

**THE THOMSON GROUP**

34 years of pioneering experience



Reliability is our heritage,  
Quality is our tradition.

**32**  
*years*  
OF MANUFACTURING  
EXPERIENCE



**ALCO**<sup>TM</sup>  
LADDERS



## About Us

Alco Ladders is the largest & finest ladder manufacturing company in India. For the last 18 years Alco ladders produced more than 10,00,000 super quality aluminium ladders, which helps a million customers to climb easily. We are well equipped with modernized ladder production equipments, testing equipments, and highly skilled technical force and accompanied with excellent professional technicians. All Alco Ladders are built to exacting specifications by skilled craftsmen for optimum safety and performance.

We got ISO 9001 - 2015 certification in the year 2006. Ever since our establishment, we have created an identity in the industry by focusing on the strategic need of our valued customers. As an independent company, we are consistently offering quality product and services that meet our customer's specific requirement.

## Vision & Mission

Providing high quality products and services at reasonable prices. We deliver what we promise to the customers on time.

## International Quality

All our ladders are made from high tensile aluminium alloys, designed and manufactured to rigorous quality standards and with a common goal of building the safest climbing equipment possible.

## Professional Grade & Safe Products

Our products are backed by years of state-of-the-art product design through testing and evaluation experience, making us the leader in climbing equipment. We manufacture a full range of safe, professional-grade products for any work and build them to withstand even the most challenging position.

We not only make safe products, but also we take safely one step further by placing a high priority on educating our customers to realize the importance of preventing ladder related injuries.

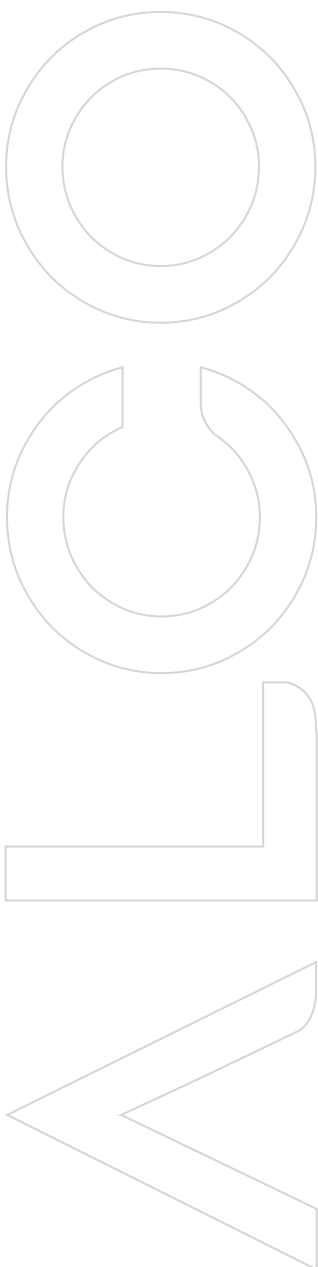

## SELF SUPPORTING DOUBLE SIDE BIG TOP LADDER



### Features

- Non slip corrugated steps and platform on top
- Highly convenient and can be used for long time
- Light in weight, tough, durable, sturdy and safer to climb
- High quality anti-skid PVC shoes provided, so that no scratches on floor and slips
- Ideal for house hold uses, electricians, plumbers, cable TV operators etc
- Anodized and powder coated quality available

### Specifications

Sides: Channel section of size 55mm x 22mm

Steps: Channel section of 52.5mm x 23mm

Top: Male/Female section of 330mm x 240mm

Load rating: 150 Kg.

Height available: 0.91m to 3.65m

## SELF SUPPORT SUPER STRONG LADDER

### Features

- 3" wide sides & corrugated aluminium step for better working
- Non slip corrugated steps and platform on top
- Highly convenient and can be used for long time
- Light in weight, tough, durable, sturdy and safer to climb
- High quality anti-skid PVC shoes provided so that no scratches on floor and slips
- Ideal for house hold uses, electricians, plumbers cable TV operators etc
- Anodized and powder coated quality available

### Specifications

Sides: Channel section of size 76mm x 20mm

Steps: Channel Section of size 74mm x 28.5mm

Top: Male/Female section of 330mm x 240mm

Load rating: 150 Kg.

Height available: 1.22m to 6.09m

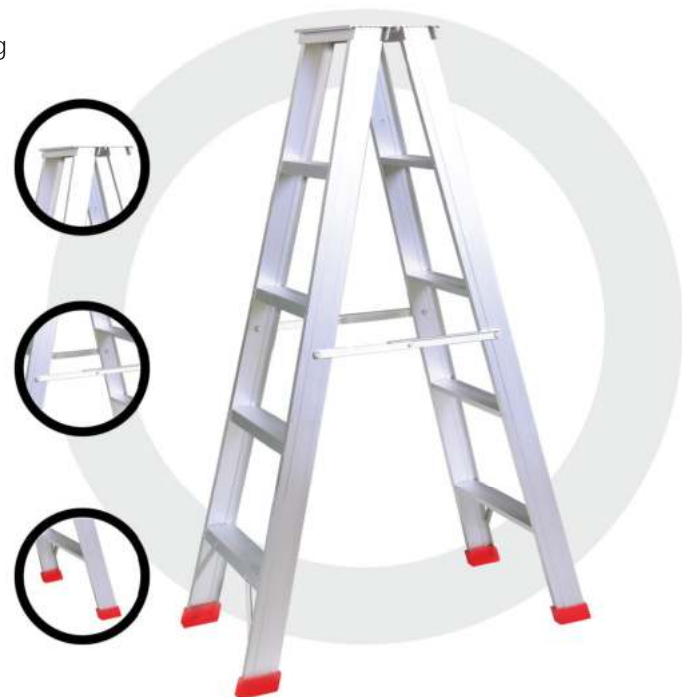

## BLACK LIFTING LADDER (Self Supporting/ Wall supporting)



### Features

- 3" wide corrugated aluminium steps for better working
- Anodized and powder coated quality available
- Ladder can be used as self support & wall support
- (Lift the supporting side upside and lock)
- Highly convenient and can be used for long time
- Light in weight, tough, durable, sturdy and safer to climb
- High quality anti-skid PVC shoes provided, so that no scratches on floor and slips
- Ideal for household uses, electricians, plumbers, cable TV operators etc

### Specifications

Sides: Channel section of size 76mm x 20mm

Steps: Channel section of 74mm x 28.5mm

Back: Channel section of 66.5mm x 31.75mm / 1" fluted pipe

Load rating: 150 Kg.

Height available is 1.52m, 1.82m & 2.14m

## SELF SUPPORTING AMERICAN LADDER

### Features

- Designed specially for domestic purpose
- Provided with a 13" x 13" Larger platform on top and arch for working safely, especially for ladies
- Non slip wide steps provided
- Highly convenient and can be used for long time
- Light in weight, tough, durable, sturdy and safer to climb
- High quality anti-skid PVC shoes provided, so that no scratches on floor and slips.
- Anodized and power coated quality available
- Nylon clips and side caps fitted

### Specifications

Sides: 40mm x 20mm rectangular tube

Steps: Channel Section of size 80.5mm x 34.6mm

Load rating: 150 Kg.

Height available is 1.52m, 1.82m & 2.14m



## STRAIGHT PIPE STEP LADDER

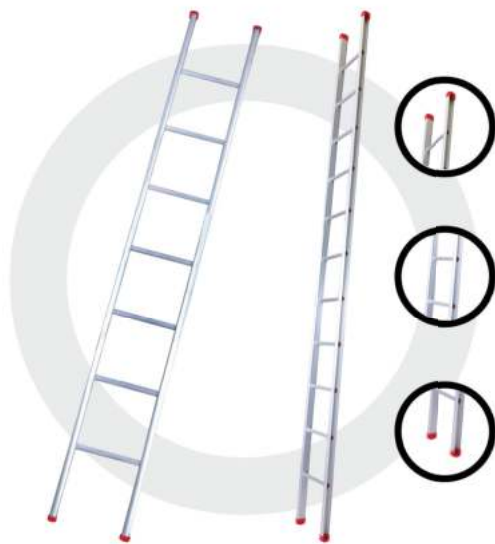

### Features

- Highly convenient and can be used for long time
- Light in weight, tough, durable sturdy and safer to climb
- High quality Rubber shoes provided, so that no scratches on floor and slips
- Ideal for house hold uses, electricians, plumbers, Maintenance field, cable TV operators etc.

### Specifications

Sides: Channel section of size 66.5mm x 31.75mm

Steps: 1" Fluted pipe section

Load rating: 150 Kg.

Height available is 1.82m to 6.09m with 2mm, 2.9mm

3.18mm & 4mm thickness

## STRAIGHT FLAT STEP LADDER

### Features

- Highly convenient and can be used for long time
- Flat steps provided for easy and long time working
- Light in weight, tough, durable sturdy and safer to climb
- High quality rubber shoes provided so that no scratches on floor and slips
- Ideal for house hold uses, electricians, plumbers, maintenance field, cable TV operators etc.

### Specifications

Sides: Channel section of size 66.5mm x 31.75mm

Steps: 1" Fluted pipe section

Load rating: 150 Kg.

Height available is 1.82m to 6.09m with 2mm, 2.9mm

3.18mm & 4mm thickness

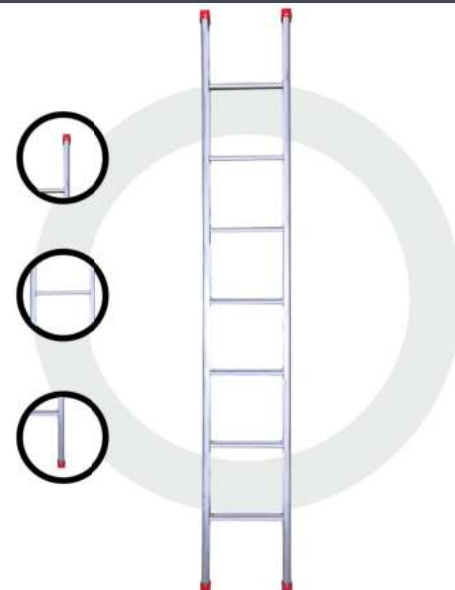

## STRAIGHT FLAT NEW TYPE LADDER

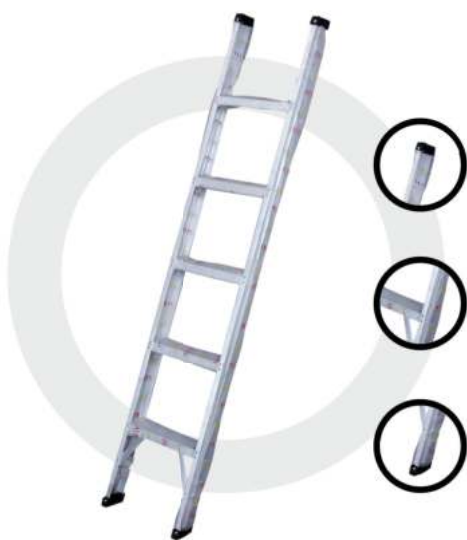

### Features

- Highly convenient and can be used for long time
- 3" sides and 3" corrugated flat steps provided for easy and long time working.
- Light in weight, tough, durable, sturdy and safer to climb
- High quality rubber shoes provided, so that no scratches on floor and slips.
- Ideal for house hold uses, electricians, plumbers, maintenance field, cable TV operators etc.
- Covered with high quality PP cover

### Specifications

Sides: Channel section of size 76mm x 20mm

Steps: Channel section of size 74mm x 28.5mm

Load rating: 150 Kg.

Height available: 1.82m to 4.82m

## WALL SUPPORT EXTENDABLE LADDER

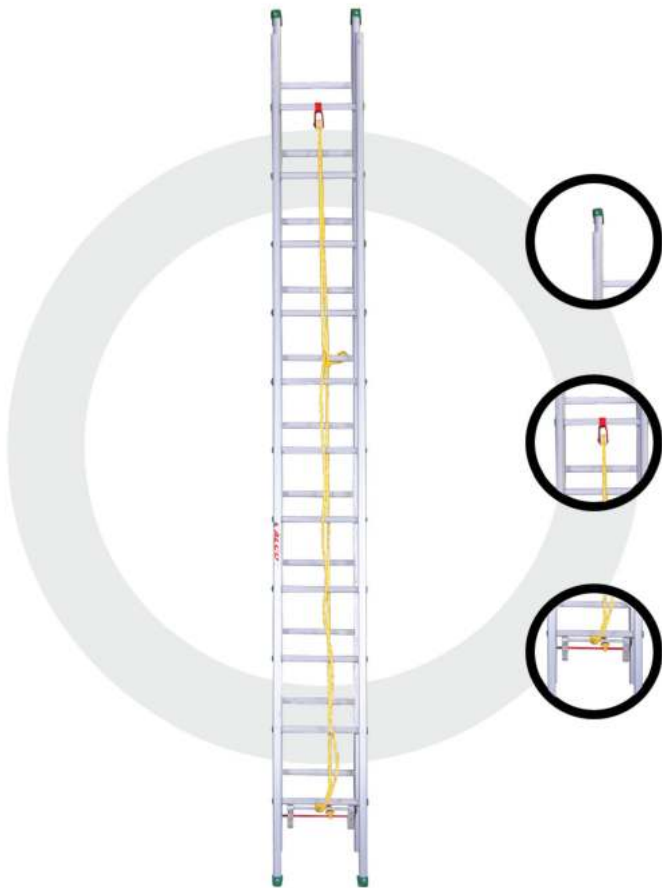

### Features

- Made from high tensile aluminium alloys
- Designed specifically to meet the requirement of all industrial maintenance
- Provided safety locks, rope, pulley and high quality rubber shoes on the top and the bottom
- Light in weight, tough, durable sturdy and safer to climb  
Extends smoothly and the lock adjusts intermediately between the steps
- Extension by pulley & rope with self lock bar which is adjustable at any interior step  
Ideal for Industrial units, Play grounds, Refineries, Ship yards Churches, Temples, Mosques and Multi -storied buildings for cleaning and maintenance purposes

### Specifications

Sides: Channel section of size 66.5mm x 31.75mm  
Steps: 1" fluted pipe section  
Thickness: 2mm, 2.9mm, 3.18mm & 4mm available  
Load rating: 150 Kg.

Height available From 4.87m to 14.64m

## SELF SUPPORT EXTENDABLE LADDER

### Features

- Designed specifically to meet requirement of all Industrial Maintenance
- Provided with safety locks, tool tray, fitter platform, rope , pulleys etc
- Mounted on MS wheelbase with 4 Nos of 8" dia nylon wheels to provide flexible and moveable operations
- It can be extended upto required height and can be closed and folded very easily
- Extends smoothly and the lock adjusts intermediately between the steps
- Particularly made for heavy works at remarkable heights
- Light in weight tough, durable sturdy and safer to climb
- Highly convenient and can be used for long time
- Extension by pulley & rope with self lock bar which is adjustable at any interior step
- Ideal for Industrial Units, Play Grounds, Refineries etc.

### Specifications

Sides: Channel section of size 66.5mm x 31.75mm  
Steps: 1" fluted pipe section  
Thickness: 2mm, 2.9mm, 3.18mm & 4 mm available  
Load rating: 150 Kg.

Height available: 4.87m to 14.64m

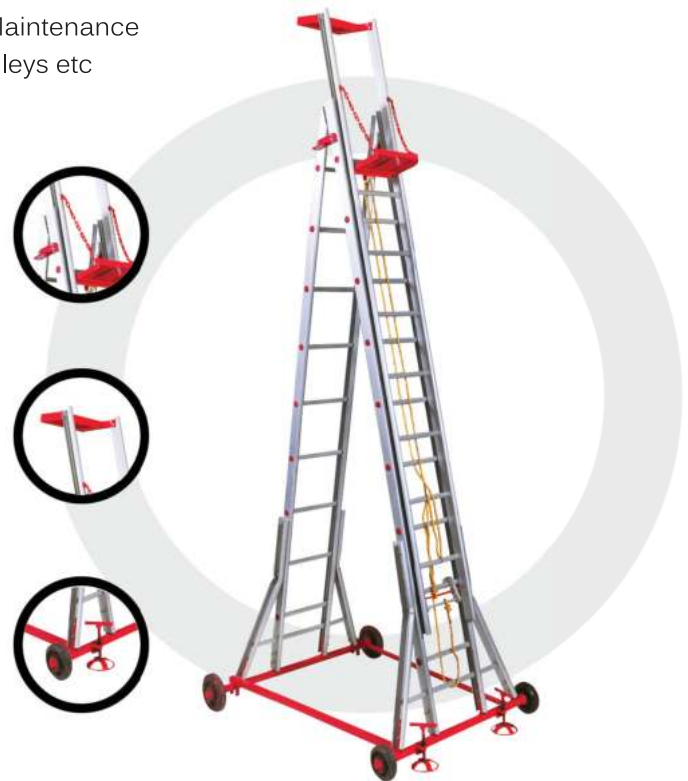

## TILTABLE TOWER EXTENDABLE LADDER



### Features

- Designed specifically to meet the requirement of all Industrial Maintenance
- Provided with safety locks, tool tray, fitter platform at 3ft from top etc.
- Mounted on MS trolley with 4Nos 12"/16" dia nylon wheels to provide easy maintenance operations
- This ladder is fabricated in two or three sections which can be tilted from 90° vertical position to 0° horizontal position to pass through small entrance or low gates
- Particularly made for heavy works at remarkable heights
- Telescopic winding is through a steel rope system controlled by manual winch gear machine
- Two winches will be provided as one for extension purpose and another for tilting purpose
- We can avail electric gear winch system also
- Highly convenient and can be used for long time

### Specifications

Sides: Channel section of size 66.5mm x31.75mm  
Steps: 1" Fluted pipe section  
Top: 3.18mm & 4mm available  
Load rating: 150 Kg.

Height available: 4.87m to 18.28

## TREE CLIMBING LADDER

### Features

- Highly convenient and can be used for long time
- 1" Corrugated fluted pipe steps provided for easy and long time working
- Light in weight tough, durable sturdy and safer to climb
- Leg supporting PVC caps provided on steps
- Can be slanted 90 degree both sides from bottom stand
- Ideal for tree climbing like coconut, betelnut, black pepper, betels, rubber tapping etc
- Nylon rope provided for easy climbing

### Specifications

Sides: 3" dia aluminium pipe  
Steps: 1" corrugated fluted pipe  
Bottom: Solid powdered coated MS base  
Top: Solid power coated MS support  
Load rating: 150 Kg.

Height available is 2.43m, 3.04m, 3.65m, 4.57m & 6.1m

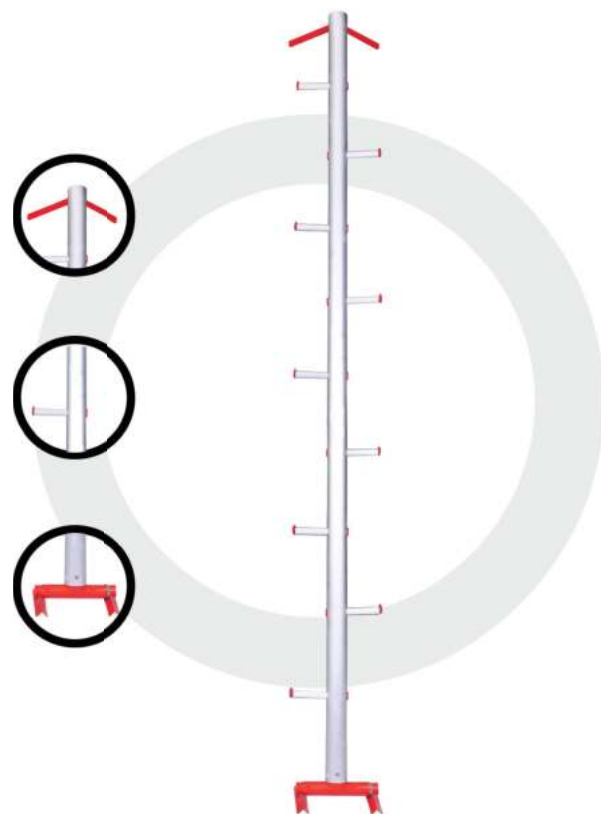



32  
*years*  
OF MANUFACTURING  
EXPERIENCE

ALCO<sup>TM</sup>  
LADDERS

